

Reprocessed by



Sustainability Solutions

Instructions for Use Reprocessed HARMONIC FOCUS® Shears + Adaptive Tissue Technology

Reprocessed Device for Single Use

Caution: Federal (U.S.A.) law restricts this device to sale by or on the order of a physician.

- **STERILE**

Explanation of Symbols

The text "Rx ONLY" in a bold, sans-serif font.	Federal Law in the USA restricts this device to sale by or on the order of a physician	The word "LOT" in a bold, sans-serif font inside a rectangular box.	Batch Code
The words "STERILE" and "EO" in a bold, sans-serif font inside a rectangular box.	Sterilized Using Ethylene Oxide	A circle with a diagonal slash through it, containing a stylized symbol.	Do Not Re-use
An hourglass icon.	Use by Date	The word "REF" in a bold, sans-serif font inside a rectangular box.	Catalogue Number
An icon of an open book with an information symbol (i) on the right page.	Consult Instructions For Use		

Reprocessed HARMONIC FOCUS® Shears + Adaptive Tissue Technology

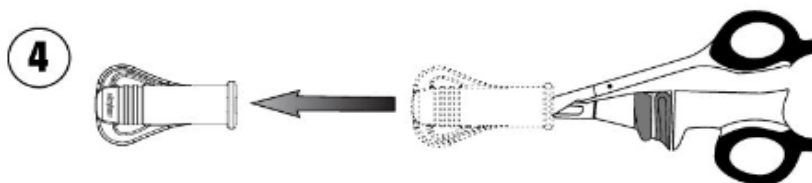
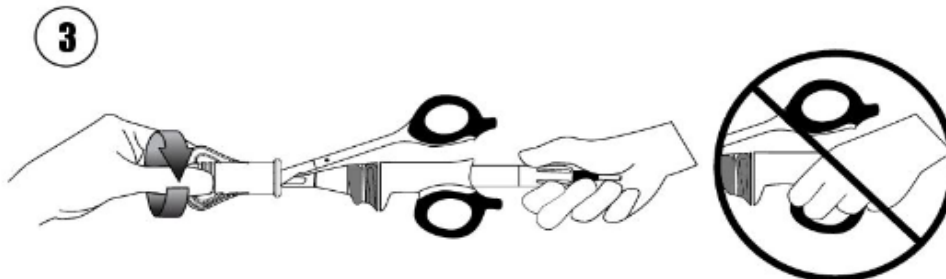
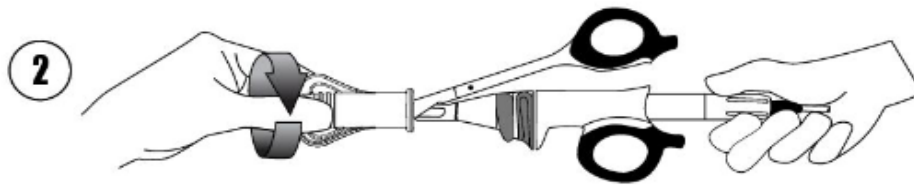
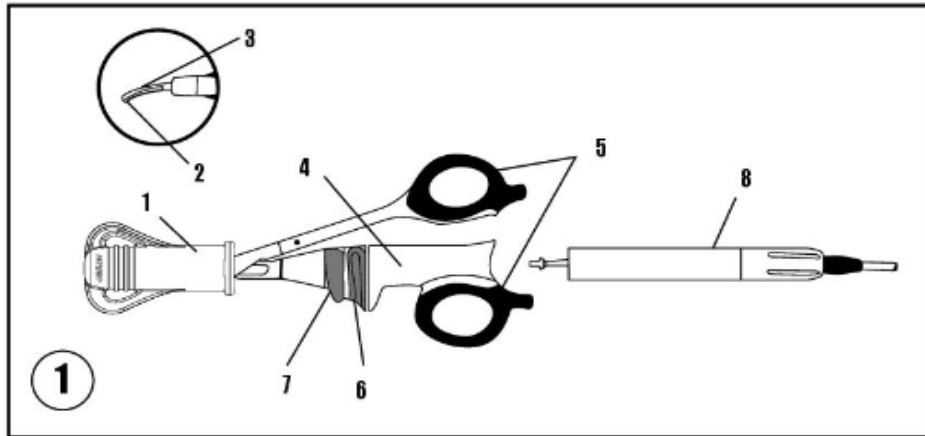

Reprocessed HARMONIC FOCUS® Shears + Adaptive Tissue Technology

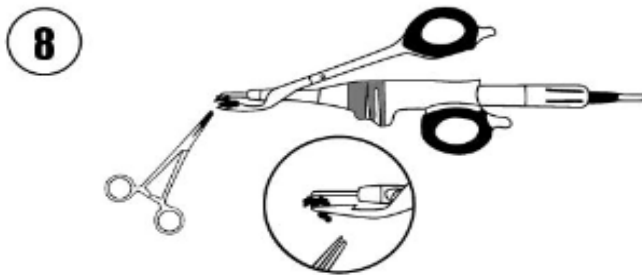
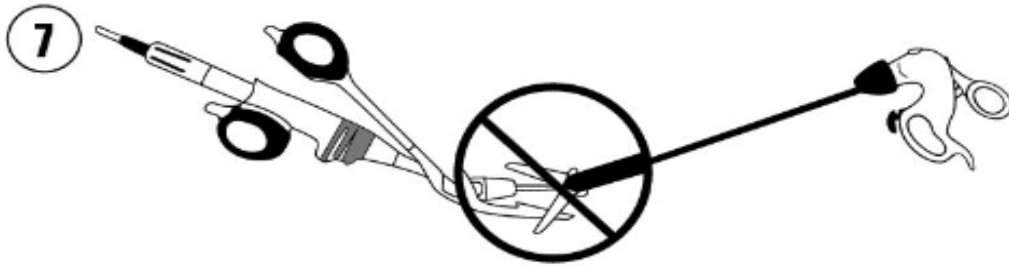
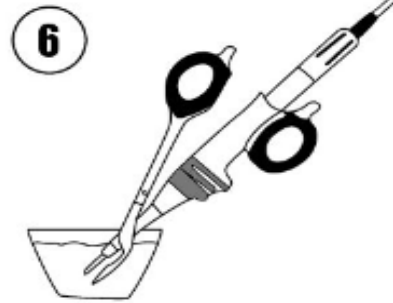
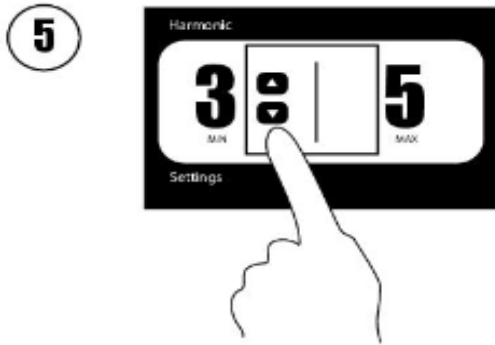

Reprocessed HARMONIC FOCUS® Shears + Adaptive Tissue Technology

Reprocessed HARMONIC FOCUS® Shears + Adaptive Tissue Technology Description

The Reprocessed HARMONIC FOCUS® Shears + Adaptive Tissue Technology is a sterile, single patient use instrument consisting of a soft grip scissor handle housing assembly with two hand controls (MIN for minimum power level and MAX for maximum power level). The instrument has a curved blade and clamp arm with teflon pad. The instrument is 9 cm in length with a 16 mm active blade length. The Reprocessed HARMONIC FOCUS®+ Shears instrument allows for the cutting and coagulation of vessels up to and including 5 mm in diameter. Each Reprocessed HARMONIC FOCUS®+ Shears instrument is packaged with one sterile, single patient use, disposable Torque Wrench. Use only the Stryker Sustainability Solutions Torque Wrench with the Reprocessed HARMONIC FOCUS® + Shears instrument.

The torque wrench should not be discarded until the completion of the surgical case. Do not attempt to sterilize the disposable torque wrench. The two dashes on the instrument are intended to represent relative vessel size. The MAX button is typically used for smaller vessels where cutting speed is fastest. The MIN button is typically used in slightly larger vessels and has reduced cutting speed. It is indicated for vessels up to 5 mm in size. Adaptive Tissue Technology provides the generator with the ability to identify and monitor the instrument during use, which enables the generator to modulate and decrease its power output as well as provide audible feedback to the user as appropriate. The Reprocessed HARMONIC FOCUS®+ Shears is designed for use exclusively with the Generator G11 (GEN11) software version 2013_1, 2014_1, or 2016_1 and Harmonic Blue Hand Piece (HPBLUE). Software revision can be found under "System Information" in the Generator G11 (GEN11) "Settings" Menu. Refer to the Generator G11 (GEN11) Operator's Manual for more information. Refer to the Instructions for Use of the Harmonic Blue Hand Piece (HPBLUE) and Test Tip (TTBLUE) for instructions regarding the Hand Piece.

Illustration and Nomenclature (Illustration 1)

- 1) Torque Wrench
- 2) Blade
- 3) Clamp Arm and Tissue Pad
- 4) Handle Housing
- 5) Finger Rings
- 6) MIN Hand Control (proximal)
- 7) MAX Hand Control (distal)
- 8) Hand Piece (Not Included)

Indications for Use

Reprocessed HARMONIC FOCUS® Shears + Adaptive Tissue Technology are indicated for soft tissue incisions when bleeding control and minimal thermal injury are desired. The instrument can be used as an adjunct to or substitute for electrosurgery, lasers, and steel scalpels in general, otorhinolaryngologic (ENT), plastic, pediatric, gynecologic, urologic, exposure to orthopedic structures (such as spine and joint space) and other open procedures.

Contraindications for Use

Reprocessed HARMONIC FOCUS® Shears + Adaptive Tissue Technology are contraindicated for:

- The instrument is not indicated for incising bone.
- The instrument is not intended for contraceptive tubal occlusion.

Warnings and Precautions

- Caution: Federal (USA) law restricts this device to sale by or on the order of a physician.
- Minimally invasive procedures should be performed only by persons having adequate training and familiarity with minimally invasive techniques. Consult medical literature relative to techniques, complications, and hazards prior to performance of any minimally invasive procedure.
- Minimally invasive instruments may vary from manufacturer to manufacturer. When minimally invasive instruments and accessories from different manufacturers are employed together in a procedure, verify compatibility prior to initiation of the procedure.
- A thorough understanding of the principles and techniques involved in laser, electrosurgical, and ultrasonic procedures is essential to avoid shock and burn hazards to both patient and medical personnel and damage to the device or other medical instruments. Ensure that electrical insulation or grounding is not compromised. Do not immerse instruments in liquid unless the instruments are designed and labeled to be immersed.
- Verify compatibility with generators. HARMONIC FOCUS®+ Shears are compatible only with Ethicon Endo-Surgery Generator G11 (GEN11) software version 2013_1, 2014_1, or 2016_1. Software revision can be found under "System Information" in the Generator G11 (GEN11) "Settings" Menu. Refer to the Generator G11 (GEN11) Operator's Manual for more information.

Reprocessed HARMONIC FOCUS® Shears + Adaptive Tissue Technology

- Audible high-pitched ringing, resonating from the blade or Hand Piece, are an abnormal condition and an indicator that the blade or Hand Piece is not operating properly. The ringing may be an indicator that the Hand Piece is beyond its useful life or that the blade has not been attached properly, which may result in abnormally high shaft temperatures and user or patient injury.
- In case of system failure, ensure the availability of the appropriate back-up equipment relevant to the specific procedure.
- Blood and tissue buildup between the blade and shaft may result in abnormally high temperatures at the distal end of the shaft. To prevent burn injury, remove any visible tissue buildup at the distal end of the shaft.
- As with all energy sources (Electrosurgery, Laser, or Ultrasound), there are concerns about the carcinogenic and infectious potential of the by-products, such as tissue smoke plume and aerosols. Appropriate measures such as protective eyewear, filtration masks, and effective smoke evacuation equipment should be used in both open and laparoscopic procedures.
- Do not attempt to bend, sharpen, or otherwise alter the shape of the blade. Doing so may cause blade failure and user or patient injury.
- To avoid user or patient injury in the event that accidental activation occurs, the instrument blade, clamp arm, and distal end of the shaft should not be in contact with the patient, drapes, or flammable materials while not in use.
- During and following activation in tissue, the instrument blade and clamp arm may become hot. Avoid unintended contact with tissue, drapes, surgical gowns, or other unintended sites at all times.
- Incidental and prolonged activation against solid surfaces, such as bone, may result in blade heating and subsequent blade failure, and should be avoided.
- Avoid contact with any and all metal or plastic instruments or objects when the instrument is activated. Contact with staples, clips, or other instruments while the instrument is activated may result in cracked or broken blades, which may be identified by generator solid tone or instrument error.
- Scratches on the blade may lead to premature blade failure.
- Care should be taken not to apply pressure between the instrument blade and tissue pad without having tissue between them. Clamping the tissue pad against the active blade without tissue on the full length of the blade will result in higher blade, clamp arm and distal shaft temperatures and can result in possible damage to the instrument. If this happens, there may be a system failure signaled by a continuous tone or alert screen when either of the foot pedals or hand control buttons is depressed.
- Keep the jaws of the device open when backcutting or while the blade is active without tissue between the blade and tissue pad to avoid damage to the tissue pad and increased blade, clamp arm, and distal shaft temperatures.
- To avoid user or patient injury, do not activate an electrosurgical device in close proximity to the Harmonic instruments. The aerosols created by the activation of the Harmonic instruments in fatty tissue are potentially flammable.
- The entire exposed blade tip and any exposed blade shaft is active and will cut/coagulate tissue when the HARMONIC FOCUS®+ Shears blade is activated. Be careful to avoid inadvertent contact between all exposed blade surfaces and surrounding tissue when using the HARMONIC FOCUS + instrument.
- Use only the Harmonic Foot Switch, and the Blue Hand Piece, with the Focus + instrument to ensure compatibility with the Generator.
- After removing the instrument, examine the tissue for hemostasis. If hemostasis is not present, appropriate techniques should be used to achieve hemostasis.
- The sealing performance of this instrument has not been assessed on atherosclerotic vessels. Exercise caution when transecting these vessels as they may not seal properly.
- Minimum starting power level defaults to power level 3.
- Successful hemostasis may require adjunct measures when HARMONIC FOCUS®+ Shears instruments are used on solid organs. Due to the difficulty of visualizing internal structures, proceed slowly and do not attempt to transect large masses of tissue in one activation. Avoid the division of large vascular/biliary bundles when using the HARMONIC FOCUS®+ Shears instrument under these conditions.
- Products manufactured or distributed by companies not authorized by Ethicon Endo-Surgery may not be compatible with the HARMONIC FOCUS®+ Shears instrument. Use of such products may lead to unanticipated results and possible injury to the user or patient.
- Do not torque the instrument by hand or damage may occur to the Hand Piece. Do not use any means other than the Torque Wrench to attach or detach the instrument from the Hand Piece.
- Take care to avoid damage to the shears when removing the Torque Wrench from the instrument.
- Do not clean the instrument with abrasives.
- Instruments or devices, which come into contact with bodily fluids, may require special disposal handling to prevent biological contamination.

Reprocessed HARMONIC FOCUS® Shears + Adaptive Tissue Technology

- Dispose of all opened instruments whether used or unused.
- This device is packaged and sterilized for single use only. Multiple patient use may compromise the device integrity or create a risk of contamination that, in turn, may result in patient injury or illness.

Directions for Use

Verify compatibility of all instruments and accessories prior to using the instrument (**refer to Warnings and Precautions**).

The Hand Piece and Test Tip, packaged separately, are shipped non-sterile and must be sterilized per the insert instructions prior to each use.

Assembly

1. Using aseptic technique, remove the instrument from the package. To avoid damage, do not flip the instrument into the sterile field.
2. While holding the Hand Piece, attach the instrument by rotating it onto the Hand Piece in a clockwise rotation as viewed from the distal end of the instrument (finger tight only) (Illustration 2).
3. Use the Torque Wrench to tighten the instrument onto the Hand Piece. Turn the wrench clockwise while holding the Hand Piece until it clicks twice, indicating that sufficient torque has been applied to secure the instrument (Illustration 3). To ensure proper assembly, do not grip the instrument handle while applying torque with the Torque Wrench.

Caution: Do not torque the instrument by hand or damage may occur to the Hand Piece. Do not use any means other than the Torque Wrench to attach or detach the instrument from the Hand Piece.

4. Remove the Torque Wrench from the instrument. Do not discard the disposable Torque Wrench until the completion of the surgical case. The Torque Wrench is used for removal of the instrument from the Hand Piece following the procedure (Illustration 4). In the event the Torque Wrench falls out of the sterile field, replace with a sterile Torque Wrench. Do not re-sterilize the disposable Torque Wrench.

Caution: Take care to avoid damage to the shears when removing the Torque Wrench from the instrument.

5. The second activation tone can be turned off under the “Settings” Menu on the G11 generator. See Generator G11 (GEN11) Operator’s Manual for more information. This will deactivate the second activation tone only; this will not affect the Adaptive Tissue Technology’s modulation and decrease of power output.

Operation

Refer to a compatible Harmonic Generator User Manual for hand piece attachment and system operation instructions.

1. Connect the assembled Hand Piece and instrument to the generator and turn the generator power on. Do not turn the generator power on before the Hand Piece and instrument are connected to the generator.
2. Select the desired variable or minimum power level using the INCREASE and DECREASE buttons on the generator.
 - Minimum starting power level defaults to power level 3 (Illustration 5). For greater tissue cutting speed use a higher generator power level, and for greater coagulation use a lower generator power level. The amount of energy delivered to the tissue and resultant tissue effects are a function of many factors, including the power level selected, blade characteristics, grip force, tissue tension, tissue type, pathology, and surgical technique.
 - MAX power is set at power level 5 and cannot be adjusted.
3. The HARMONIC FOCUS®+ Shears instrument may be operated with either the foot switch or hand control. For foot switch or hand control function, refer to a compatible Harmonic Generator User Manual for further detail and setup and operation instructions.
4. For optimal performance, clean the instrument blade and clamp arm throughout the procedure by activating the instrument tip in sterile saline (Illustration 6). The instrument can be wiped with a sterile moist gauze sponge to remove tissue, if necessary.

WARNING: Do not touch the instrument to metal while activated (Illustration 7). See Warnings and Precautions.

5. If tissue is still visible in the clamp arm, use hemostats to remove residue (Illustration 8).
6. The blade is ultrasonically energized when either the foot switch pedal is depressed or one of the hand controls is depressed.
 - Pressing either the left foot pedal of the foot switch or the proximal hand control (MIN) on the instrument activates the selected minimum power level.
 - Pressing either the right foot pedal of the foot switch or distal hand control (MAX) on the instrument activates the maximum power level.
 - The generator provides an audible tone to indicate when the instrument blade is active.
 - The generator changes to a second activation tone as Adaptive Tissue Technology regulates the delivery

Reprocessed HARMONIC FOCUS® Shears + Adaptive Tissue Technology

of energy.

- Thermal influences such as fluids or minimal to no tissue in the jaws may affect the presence or timing of the tone change.
- The tone change does not provide confirmation of tissue effect. When the second tone is heard, the situation should be assessed and the intended surgical action completed, such as gradual application of tension to facilitate transection.
- The secondary activation tone change is not a substitute for surgical experience.

WARNING: Avoid accidental contact with other instruments during use. Scratches on the blade may lead to premature blade failure. See Warnings and Precautions.

7. Close the clamp arm and insert the instrument through the incision. Use the HARMONIC FOCUS®+ Shears for dissection, grasping, coagulation, and cutting between the blade and clamp arm. Use the top of the blade with the clamp arm open if using for backcutting.

WARNING: Keep the clamp arm open when backcutting or while the blade is active, without tissue between the blade and tissue pad, to avoid damage to the tissue pad.

Disassembly

1. Turn the generator OFF at the power switch.
2. Close the clamp arm and place the Torque Wrench over the distal end of the instrument.
3. While holding the Hand Piece, loosen the instrument by turning the Torque Wrench counterclockwise. Continue to loosen by turning the instrument manually to completely unscrew it from the Hand Piece.
4. Remove the Torque Wrench from the instrument. Dispose of the instrument and the Torque Wrench in an appropriate container.

Storage and Handling

- **Temperature:** -20°C to +50°C
- **Relative Humidity:** 25–90%

How Supplied

The HARMONIC FOCUS® + Shears and Torque Wrench are supplied sterile.

Warranty

Reprocessed Products

Stryker warrants all reprocessed products, subject to the exceptions provided herein, to be free from defects in reprocessing and to substantially conform to the product specifications contained in the documentation provided by Stryker with the products for one use in accordance with the instructions for use of such product.

STRYKER SHALL NOT BE LIABLE FOR ANY DAMAGES TO THE EXTENT CAUSED BY ANY DEFECT IN MATERIAL, WORKMANSHIP OR DESIGN BY THE ORIGINAL MANUFACTURER OF THE PRODUCT OR ANY ACT OR OMISSION OF THE ORIGINAL MANUFACTURER OF THE PRODUCT.

Products for which Stryker is the Original Manufacturer

Stryker warrants all products for which it is the original manufacturer, subject to the exceptions provided herein, to be free from defects in design, materials and workmanship and to substantially conform to the product specifications contained in the documentation provided by Stryker with the products for a period of one year from the date of purchase.

General Warranty Terms Applicable to All Products

TO THE FULLEST EXTENT PERMITTED BY LAW, THE EXPRESS WARRANTY SET FORTH HEREIN IS THE ONLY WARRANTY APPLICABLE TO THE PRODUCTS AND IS EXPRESSLY IN LIEU OF ANY OTHER WARRANTY BY STRYKER, EXPRESSED OR IMPLIED, INCLUDING, BUT NOT LIMITED TO, ANY IMPLIED WARRANTY OR MERCHANTABILITY OR FITNESS FOR A PARTICULAR PURPOSE. IN NO EVENT WILL STRYKER'S LIABILITY ARISING IN CONNECTION WITH THE SALE OF THE PRODUCT (WHETHER UNDER THE THEORIES OF BREACH OF CONTRACT, TORT, MISREPRESENTATION, FRAUD, WARRANTY, NEGLIGENCE, STRICT LIABILITY OR ANY OTHER THEORY OF LAW) EXCEED THE PURCHASE PRICE, CURRENT MARKET VALUE OR RESIDUAL VALUE OF THE PRODUCTS, WHICHEVER IS LESS. STRYKER SHALL NOT BE LIABLE FOR INDIRECT, SPECIAL,

Reprocessed HARMONIC FOCUS® Shears + Adaptive Tissue Technology

INCIDENTAL, PUNITIVE OR CONSEQUENTIAL DAMAGES RESULTING FROM ANY BREACH OF WARRANTY OR UNDER ANY OTHER LEGAL THEORY.

This warranty shall apply only to the original end-user purchaser of products directly from Stryker or a Stryker authorized distributor. This warranty may not be transferred or assigned without the express written consent of Stryker.

This warranty does not apply to: (1) products that have been misused, neglected, modified, altered, adjusted, tampered with, improperly installed or refurbished; (2) products that have been repaired by any person other than Stryker personnel without the prior written consent of Stryker; (3) products that have been subjected to unusual stress or have not been maintained in accordance with the instructions in the user manual or as demonstrated by a Stryker representative; (4) products on which any original serial numbers or other identification marks have been removed or destroyed; or (5) products that have been repaired with any unauthorized or non-Stryker components.

If a valid warranty claim is received within thirty (30) days of the expiration of the applicable warranty period, Stryker will, in its sole discretion: (1) replace the product at no charge with a product that is at least functionally equivalent to the original product or (2) refund the purchase price of the product. If a refund is provided by Stryker, the product for which the refund is provided must be returned to Stryker and will become Stryker's property. In any event, Stryker's liability for breach of warranty shall be limited to the replacement value of the defective or non-conforming part or component.

If Stryker determines in its reasonable discretion that the claimed defect or non-conformance in the product is excluded from warranty coverage as described hereunder, it will notify the customer of such determination and will provide an estimate of the cost of repair of the product. In such an event, any repair would be performed at Stryker's standard rates.

Products and product components repaired or replaced under this warranty continue to be warranted as described herein during the initial applicable warranty period or, if the initial warranty period has expired by the time the product is repaired or replaced, for thirty (30) days after delivery of the repaired or replaced product. When a product or component is replaced, the item provided in replacement will be the customer's property and the replaced item will be Stryker's property. If a refund is provided by Stryker, the product for which the refund is provided must be returned to Stryker and will become Stryker's property.

The OEM information listed on the label is provided as device ID prior to reprocessing and may contain the trademarks of unrelated third parties that do not sponsor this device.

Sterilization: This product and its packaging have been sterilized with ethylene oxide gas (EtO). Even though the product then is processed in compliance with all applicable laws and regulations relating to EtO exposure, Proposition 65, a State of California voter initiative, requires the following notice:

Warning: This product and its packaging have been sterilized with ethylene oxide. The packaging may expose you to ethylene oxide, a chemical known to the State of California to cause cancer or birth defects or other reproductive harm.

Harmonic, HARMONIC FOCUS and UltraCision are trademarks of Ethicon Endo-Surgery.

ULS EL10057 Rev. C 08/2017 S16-10267

Stryker Sustainability Solutions Inc.
1810 W Drake Dr
Tempe, AZ 85283
USA
Sustainability.Stryker.com
+1 480-763-5300